

Nylon Closed Snap Bushing



RoHS COMPLIANT

Specifications:

Material: Nylon 6/6
UL Rating: 94V-2
Color: Black
UL Listed: See Logo

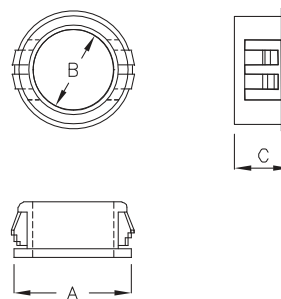

Part Number	Panel Thickness, mm [in.]	Hole Dia. In Panel, ø, mm [in.]	Dia. "A", ø, mm [in.]	Dia. "B", ø, mm [in.]	Ref. "C", mm [in.]	Standard Package
PCP-SB-0305	1.6-1.7 [0.063-0.067]	ø4.8 [0.189]	ø6.5 [0.256]	ø3.2 [0.126]	6.0 [0.236]	1000
PCP-SB-0710	0.8-1.8 [0.031-0.071]	ø10.0 [0.394]	ø12.1 [0.476]	ø7.2 [0.283]	6.6 [0.260]	500
PCP-SB-1013	0.8-3.0 [0.031-0.118]	ø13.0 [0.512]	ø15.3 [0.602]	ø10.2 [0.402]	9.1 [0.358]	
PCP-SB-1316	1.4-3.5 [0.055-0.138]	ø16.0 [0.630]	ø18.0 [0.709]	ø12.8 [0.504]	10.4 [0.409]	
PCP-SB-1316K	0.8-1.8 [0.031-0.071]	ø16.0 [0.630]	ø18.0 [0.709]	ø12.8 [0.504]	10.4 [0.409]	200
PCP-SB-1519	1.0-3.0 [0.039-0.118]	ø19.0 [0.748]	ø21.7 [0.854]	ø15.3 [0.602]	11.1 [0.437]	
PCP-SB-1822	0.9-2.3 [0.035-0.091]	ø22.0 [0.866]	ø24.8 [0.976]	ø18.2 [0.717]	11.5 [0.453]	100
PCP-SB-2428	1.0-3.3 [0.039-0.130]	ø28.0 [1.102]	ø31.5 [1.240]	ø24.1 [0.949]	11.3 [0.445]	
PCP-SB-2530	1.0-3.1 [0.039-0.122]	ø30.0 [1.181]	ø33.0 [1.299]	ø25.0 [0.984]	11.5 [0.453]	200
PCP-SB-2634	1.0-2.8 [0.039-0.110]	ø34.2 [1.346]	ø38.0 [1.496]	ø26.2 [1.031]	11.5 [0.453]	
PCP-SB-3338	6.4-6.4 [0.252-0.252]	ø38.1 [1.500]	ø41.2 [1.622]	ø33.3 [1.311]	14.3 [0.563]	

Nylon Closed Snap Bushing Low Profile Design for Thin Chassis



RoHS COMPLIANT

Specifications:

Material: Nylon 6/6
UL Rating: 94V-2
Color: Black
UL Listed: See Logo

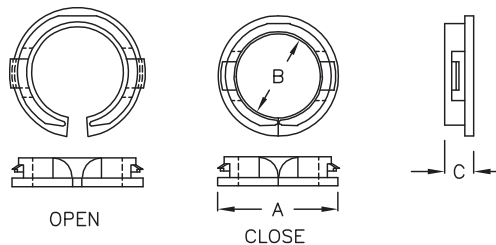

Part Number	Panel Thickness, mm [in.]	Hole Dia. In Panel, ø, mm [in.]	Dia. "A", ø, mm [in.]	Dia. "B", ø, mm [in.]	Ref. "C", mm [in.]	Standard Package
PCP-SA-0407A	0.7-0.9 [0.028-0.035]	ø6.8-7.0 [0.268-0.276]	ø9.8 [0.386]	ø4.8 [0.189]	5.0 [0.197]	1000
PCP-SA-1013A	1.0-1.5 [0.039-0.059]	ø13.0 [0.512]	ø15.5 [0.610]	ø9.6 [0.378]	5.4 [0.213]	500
PCP-SA-1013C	1.9-2.0 [0.075-0.079]	ø13.0 [0.512]	ø15.5 [0.610]	ø9.6 [0.378]	5.9 [0.232]	
PCP-SA-1316A	1.0-1.4 [0.039-0.055]	ø16.0 [0.630]	ø18.4 [0.724]	ø12.5 [0.492]	5.4 [0.213]	
PCP-SA-1519A	0.8-1.0 [0.031-0.039]	ø19.0 [0.748]	ø21.8 [0.858]	ø14.9 [0.587]	5.7 [0.224]	
PCP-SA-1822A	0.8-1.0 [0.031-0.039]	ø22.0 [0.866]	ø24.6 [0.969]	ø17.6 [0.693]	5.6 [0.220]	
PCP-SA-2024A1	0.8-1.0 [0.031-0.039]	ø24.0 [0.945]	ø26.0 [1.024]	ø20.0 [0.787]	5.4 [0.213]	200
PCP-SA-2024A	1.0-1.2 [0.039-0.047]	ø24.0 [0.945]	ø26.0 [1.024]	ø20.0 [0.787]	5.3 [0.209]	
PCP-SA-2327A	0.4-1.0 [0.016-0.039]	ø27.0-27.2 [1.063-1.071]	ø30.6 [1.205]	ø23.0 [0.906]	6.0 [0.236]	
PCP-SA-2529A	0.4-1.1 [0.016-0.043]	ø29.0 [1.142]	ø32.6 [1.283]	ø25.0 [0.984]	7.0 [0.276]	

Nylon Open Snap Bushing

RoHS COMPLIANT

Specifications:

Material: Nylon 6/6
UL Rating: 94V-2
Color: Black
UL Listed: See 



Fig. 1

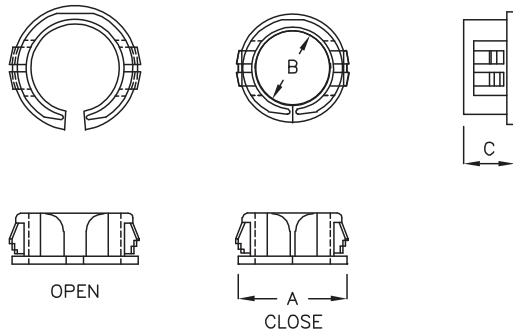
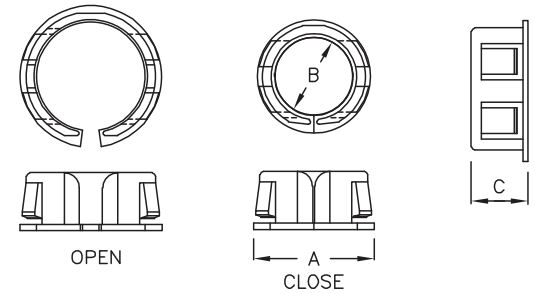









Fig. 2



Part Number		Panel Thickness, mm [in.]	Hole Dia. In Panel, ϕ , mm [in.]	Closed Dia. "A", ϕ , mm [in.]	Dia. "B", ϕ , mm [in.]	Ref. "C", mm [in.]	Standard Package
Refer to Fig. 1 for Drawing							
PCP-SB-0609A		0.7-1.7 [0.028-0.067]	ϕ 9.5 [0.374]	ϕ 11.4 [0.449]	ϕ 6.6 [0.260]	6.5 [0.256]	1000
PCP-SB-1013A		0.8-3.5 [0.031-0.138]	ϕ 13.0 [0.512]	ϕ 14.9 [0.587]	ϕ 9.0 [0.354]	10.5 [0.413]	
PCP-SB-1216A		0.7-3.3 [0.028-0.130]	ϕ 16.0 [0.630]	ϕ 18.6 [0.732]	ϕ 12.3 [0.484]	10.0 [0.394]	500
PCP-SB-1316A		1.2-3.5 [0.047-0.138]	ϕ 16.0 [0.630]	ϕ 18.0 [0.709]	ϕ 10.5 [0.413]	10.5 [0.413]	
PCP-SB-1519A		1.2-3.3 [0.047-0.130]	ϕ 19.0 [0.748]	ϕ 20.6 [0.811]	ϕ 14.4 [0.567]	11.0 [0.433]	200
PCP-SB-1720A		0.8-1.0 [0.031-0.039]	ϕ 20.0 [0.787]	ϕ 23.5 [0.925]	ϕ 17.0 [0.669]	7.2 [0.283]	500
PCP-SB-1822A		1.0-3.5 [0.039-0.138]	ϕ 22.0 [0.866]	ϕ 24.8 [0.976]	ϕ 17.3 [0.681]	11.5 [0.453]	200
PCP-SB-1922A		0.8-1.2 [0.031-0.047]	ϕ 22.0 [0.866]	ϕ 25.0 [0.984]	ϕ 19.0 [0.748]	7.4 [0.291]	500
Refer to Fig. 2 for Drawing							
PCP-SB-2024A		0.8-1.2 [0.031-0.047]	ϕ 24.0 [0.945]	ϕ 26.4 [1.039]	ϕ 20.0 [0.787]	11.3 [0.445]	
PCP-SB-2126A		0.8-1.2 [0.031-0.047]	ϕ 25.4-25.6 [1.000-1.008]	ϕ 27.7 [1.091]	ϕ 21.1 [0.831]	8.0 [0.315]	500
PCP-SB-2228A		0.8-1.2 [0.031-0.047]	ϕ 27.8 [1.094]	ϕ 28.8 [1.134]	ϕ 22.0 [0.866]	9.0 [0.354]	200

all dimension units in millimeter (mm) unless noted otherwise

www.vaisis.com | P: 626-795-6696 | F: 626-795-6896 | Email: sales@vaisis.com

Vaisis